

Hilde

INSTALLATION AND OPERATION MANUAL
HH-S91918SS / HH-S91918BK /
HH-S61918BK

SLIM HOOD

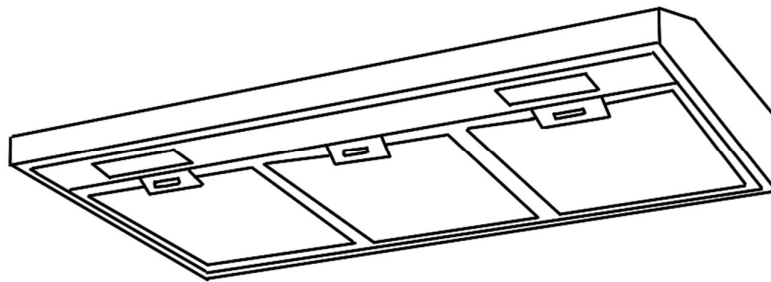

CONTENT PAGE

SAFETY PRECAUTIONS.....	3
SPECIFICATIONS	5
INSTALLATION	7
OPERATION	9
MAINTENANCE AND CARE	10
TROUBLE-SHOOTING.....	11

To all, please provide this manual to the user without fail.

Thank you very much for your purchase of our cooker hood.

Before using this appliance for the first time, please read this manual thoroughly to install, operate and care for the appliance correctly and safely.

This manual contains instructions related to installation, use and maintenance of the appliance.

Please register your product warranty at:

www.hilde.com.sg

SAFETY PRECAUTIONS

When unpacking

- Do not use the appliance if there are obvious signs of transportation damage.
- If the supply cord has been damaged, it must be replaced by the manufacturer, its service agents or qualified personnel in order to avoid a hazard. Please contact us in an event like this.

Installation

- This hood can be installed in recirculation and ventilation mode.
- It can be installed over gas and electric cooktop. The cooker hood should be placed at a distance of 700 mm above the cooktop for the best effect and to avoid fire hazard.
- This cooker hood is intended for hobs with at most 4 hob elements or burners.
- Always mount the hood over the centre of the hob.
- Use a cooker hob range with a narrower width than that of cooker hood.
- Do not install the cooker hood in wet area/ rooms as it may result in electric shock or damage.
- Ensure that the appliance is installed in a location with good permanent ventilation.
- Installation and repair should be attempted by qualified technical personnel only.
- Electrical connection must be made in accordance with local standards only. Incorrect wiring may result in fire or electric shock.
- Take note to plug the unit into a properly earthed outlet.
Green & Yellow: Earth/ Blue: Neutral/ Brown: Live

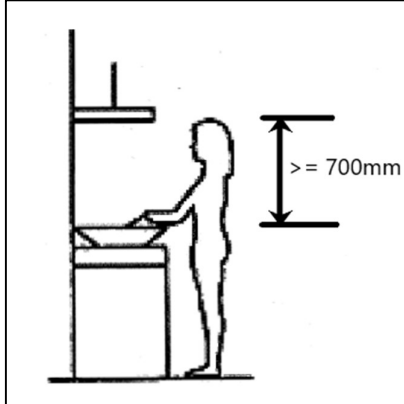

SAFETY PRECAUTIONS

Usage

- This hood is designed for domestic kitchen use to eliminate unpleasant odours from the kitchen. Do not use or install this hood for any other uses than its specific purpose.
- This appliance can be used by children aged 8 years and above and also persons with reduced physical, sensory or mental capabilities if they have been given supervision or instruction concerning the use of the appliance in a safe way and understand the hazards involved.
- Young children should not play or operate the appliance.
- Refrain from modifying any part of this appliance. Tampering with electrical connections or mechanical parts can cause operation faults and may put the user at risk.
- Ensure that the power supply chord is free from any heat source or sharp objects.
- Multiple plugs and extension cables must not be used. Overloading may cause a fire.
- Do not put anything on the cooker hood as it may cause fire, failure or injury by dropping.
- Do not switch on the cooker hood if there is a possibility of a gas leak from your gas hob as it may result in a gas explosion.
- Accessible parts may become hot when used with cooking appliances. Do not touch the filter or parts around it while cooking.
- Always cover lit burners with cookware, do not leave high naked flames under the cooker hood when it is in operation.
- Do not flambé or grill with an open flame directly under the cooker hood. Flames could be drawn up into the hood by the suction and the grease filters may catch fire.
- Do not operate the cooker hood without a grease filter.
- Always disconnect the unit from the power supply before carrying out any cleaning or maintenance work on the hood, including replacement of light bulbs to avoid the possibility of electric shock.
- Replace defective lights immediately to prevent the remaining lights from overloading.
- Clean and/or replace the filters at appropriate intervals. Grease deposits build-up increases the risk of fire.

Disposal

- Before disposing of an old appliance, disconnect it from the power supply and remove the power cord to prevent hazards.
- Please dispose the packaging in a proper manner and recycle any old appliances.

Note: The manufacturer will not be held liable for any damages resulting from improper installation nor failure to adopt proper safety measures during installation and operational use of the appliance.

SPECIFICATIONS

	Model:	HH-S61918BK
	Power Rating:	153W
	Voltage:	220-240V~
	Power Frequency:	50Hz
	Power of Motors:	2 x 75W
	Power of Lamps:	2 x 1.5W
	Length of the cable:	1m
	Appliance Dimensions:	100 x 596 x 500 mm
	Net Weight:	4.9 KGS
	*The manufacturer reserves the right to effect any technological improvement or modification without prior notice.	

	Model:	HH-S91918BK
	Power Rating:	153W
	Voltage:	220-240V~
	Power Frequency:	50Hz
	Power of Motors:	2 x 75W
	Power of Lamps:	2 x 1.5W
	Length of the cable:	1m
	Appliance Dimensions:	100 x 896 x 500 mm
	Net Weight:	6.8 KGS
	Model:	HH-S91918SS
	Power Rating:	154W
	Voltage:	220-240V~
	Power Frequency:	50Hz
	Power of Motors:	2 x 75W
	Power of Lamps:	2 x 2W
	Length of the cable:	1m
	Appliance Dimensions:	100 x 896 x 500 mm
	Net Weight:	6.8 KGS
	*The manufacturer reserves the right to effect any technological improvement or modification without prior notice.	

SPECIFICATIONS

HH-S91918BK HH-S91918SS	
Qty	Product Parts
1	Non return flap
1	Air outlet cover
1	Hood body
2	Charcoal filter CP918
3	Aluminum grease filter
Qty	Installation Accessories
6	Wall plug
6	Screw ST4*25
Qty	Documentation
1	Operation Manual
1	Warranty sticker

HH-S61918BK	
Qty	Product Parts
1	Non return flap
1	Air outlet cover
1	Hood body
2	Charcoal filter CP918
2	Aluminum grease filter
Qty	Installation Accessories
6	Wall plug
6	Screw ST4*25
Qty	Documentation
1	Operation Manual
1	Warranty sticker

Note: Power plug is not included.

If needed, please use power plug in accordance with local standards only.

INSTALLATION

This appliance can be installed in recirculation or ventilation mode.

Ducted Mode

The cooker hood fan extracts the cooking vapours and passes them to the outside. In this mode, only grease filters are installed (charcoal filter is optional).

Recirculation Mode

The cooker hood fan extracts the cooking vapours which are purified in the grease filter and charcoal filter. The purified air is then recirculated back into the kitchen via a vent opening in the hood. **Both grease filters and charcoal filters are installed.**

Mounting

Do ensure that the appliance is mounted on a solid surface which could withstand the appliance's weight.

In the case of boarded wall,

- If the thickness is more than 20mm, mount the cooker hood directly to the wall.
- If the thickness is less than 20mm, embed a reinforcing board and mount the cooker hood to this board.

In the case of a concrete/tile faced wall,

- Embed a reinforcing board in the wall in advance or use a curl plug or the like.

A. Wall Mounting

Step 1

- Determine where the hood should be positioned and lightly mark where the lower edge of the appliance should be on the wall. Determine where the middle should be based on the hob.
- Mark where the screws should be inserted according to the center distance of the hole on the back of the slim hood.
- Drill 2* 8mm diameter holes to a depth of 40mm for fastening the appliance and press in the plastic wall plugs flush with the wall.
- Tighten 2pcs of the provided ST4 x25 screws into the plastic wall plugs.

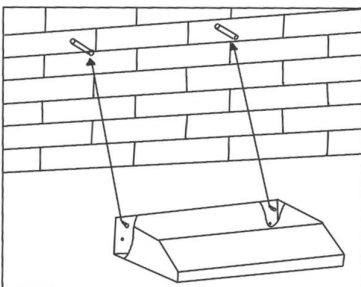

B. Cabinet Mounting

Step 1

- Determine where the hood should be positioned on the bottom of the cabinet. Determine where the middle should be based on the hob.
- Drill 4* 6mm diameter holes for fastening the appliance.

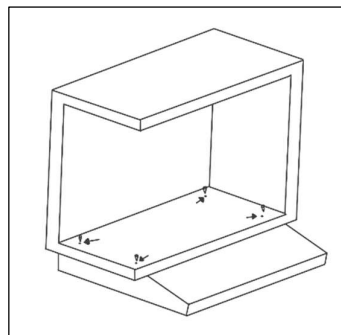

INSTALLATION

Step 2

- a. Mount the cooker hood onto the tightened screws.
- b. Fix the cooker hood with safety screws positioned on the back casing with a 6mm diameter.
- c. Put the one-way valve onto the hood to finish installation.

Step 2

- a. Put the one-way valve on the cooker hood.
- b. Align the cooker hood with the holes and fix position by screwing in with 4pcs of the provided ST4*25 screws.

Step 3

● For recirculation mode,

- Ensure that the adjuster is turned to indoor position and install the outlet cover.
- Ensure that charcoal filters have been inserted before operating the appliance.

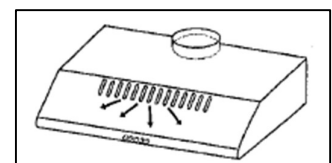
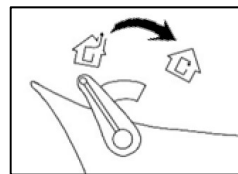

● For ducted mode,

- Use Ø120mm pipe* (flexible if possible) and fix it with a pipe-tightening ring at the reduction fitting.
- Connect the pipe to the outdoor duct.
- Remove charcoal filters and use only grease filter for more powerful suction

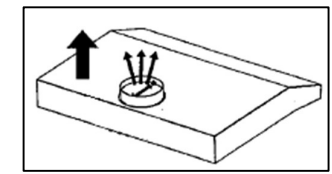
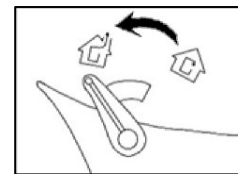

*Parts required for ducted mode installation not provided

Note: Installation and repair should be attempted by qualified technical personnel only.

The manufacturer will not be held liable for any damages resulting from improper installation nor failure to adopt proper safety measures during installation and operational use of the appliance.

OPERATION





This appliance is equipped with 3 speed controls. Function controls of the cooker hood can be found below.

To achieve better air extraction, it is advisable to switch on the cooker hood a few minutes before starting to cook and to leave it on for approximately 15 minutes after cooking (or at least until all cooking smell is completely removed).

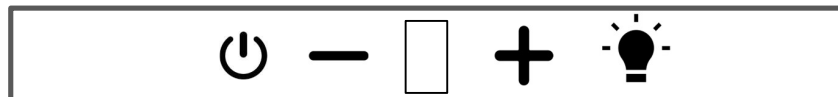
Touch Control





Note: Touch the sensor buttons gently to operate this appliance.

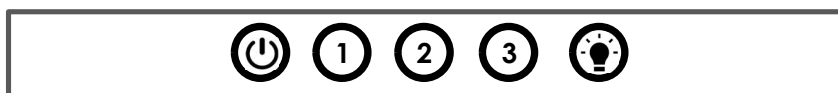

Button	Function
	On / Off Button. Used for turning on/off the fan.
	Speed decrease button. For decreasing speed of the fan.
	Speed increase button. For increasing speed of the fan.
	Light button. Touch for on/off.
	Digital display. Fan speed display: “1” for low speed, “2” for medium speed, “3” for high speed.

Push Button Control



Button	Function
	Off button. To turn off the fan.
	Low speed button. Used for ventilation in the kitchen. Suitable for simmering and cooking which do not produce much steam.
	Medium speed button. Used for standard cooking operation.
	High speed button. Use for highest effective ventilation. Suitable for when high density of smoke or steam is produced.
	Light button. Push for on/off.

MAINTENANCE AND CARE

Always ensure the appliance is disconnected from the main power supply before carrying out any cleaning or maintenance activities. It is important to clean and/or replace the filters at appropriate intervals as grease deposits build-up increases the risk of fire.

Grease Filters

- Do not operate the cooker hood without a grease filter, they are used to absorb the grease particles formed during the cooking process.
- Filters must be removed and cleaned once a month or depending on how often the appliance is used.
- Filter should be washed by hand. To do so, remove them from the cooker and soak in detergent solutions of not more than 60°C for an hour before rinsing off.
- If utilising the dishwasher, filters should be positioned vertically to improve the cleaning process.
- Take care not to bend the filters during washing.
- Please see diagram for directions on removing and inserting the filter.



Charcoal Filters

- Charcoal filters are recommended to be replaced every 6 months to 1 year or when its noticeably dirty or discoloured, depending on conditions of use.
- These filters are not reusable and has to be disposed of appropriately after replacement. Regular maintenance is necessary as clogged filters restrict airflow and may cause the motor to overheat.
- Lock the filter in place by turning clockwise and loosen by turning anti-clockwise.

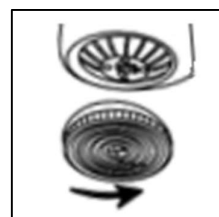

Cleaning the appliance body

- Use a soft cloth moistened with hand-warm mildly soapy water or household cleaning detergent to wipe down the exterior of the cooker hood and wipe any moisture off using a dry cloth.
- Do not use metal pads, chemical or abrasive material or stiff brush to clean the appliance as it may damage the surface.
- Prevent electric parts such as the motor, switch, connectors from coming into contact with water.

Replacing the LED

- Ensure that the appliance is disconnected from the main power supply.
- Replace the LED with another which has the same characteristics as a higher voltage lamp could damage the electrical unit.
- Remove the grease filters and push out the light.
- Disconnect the wire from the terminal.
- Replace the light and reconnect the terminal.
- Press the light back into cavity and place back grease filters.
- Please reach out to the Hilde Service Care Team for LED light replacement if you face any difficulties.

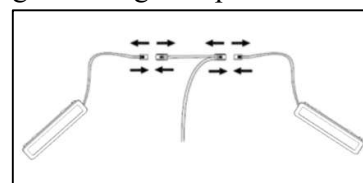

Note: The manufacturer will not be held liable for any damages resulting from improper installation nor failure to adopt proper safety measures during installation and operational use of the appliance.

TROUBLE-SHOOTING

Listed below are common problems encountered by users and suggested ways to resolve them. If in doubt, feel free to reach out to our customer service team on www.hilde.com.sg and we will further advise on the next steps. If problems still persist after the checks, please reach out to Hilde Service Care Team for further assistance.

For service calls, please provide the model number of your appliance and note that it is necessary to provide your proof of purchase for warranty purposes.

Problem	Possible Cause	Solution
Light is working but the fan is not running.	The fan blade is damaged	Switch off the unit and reach out to qualified service personnel for repair.
	The motor is damaged	
Both light and fan not working.	The LED is not working.	Check connection is tight/ Replace if LED is damaged.
	The power cord is loose	Check that plug is safely connected and main power is switched on
Hood suction is not effective	Inadequate ventilation	Ensure that the kitchen is sufficiently ventilated to allow entry of fresh air
	Distance between the cooker hood and the cooktop are too far apart	Readjust the distance to be minimum of 700mm
	Charcoal filters are not installed	Install charcoal filters for recirculation mode use
	Grease filters are clogged.	Clean grease filter and refit when dry.
	Charcoal filters are clogged.	Replace charcoal filter.
Serious vibration of the unit	The fan blade is damaged	Switch off the unit and reach out to qualified service personnel for repair.
	The fan motor is not fixed tightly	

Hilde

www.hilde.com.sg

The Company reserves the right to change the information of this installation and operation manual at any time without prior notice. In the event that any changes are made, the revised information shall be posted on www.hilde.com.sg immediately. Please check the latest information posted herein to inform yourself of any changes.